

10A 3 Gang 2 Way Switch - Traditional Plate

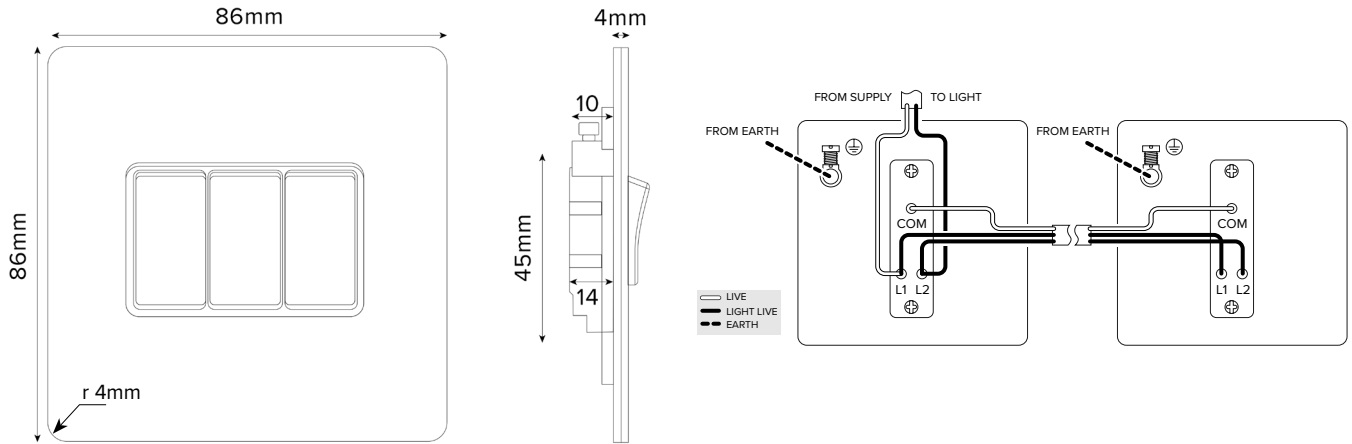

TECHNICAL SPECIFICATION

Standard(s)	BS EN 60669-1
Voltage Rating	10 A(X), 250V [~]
Contact Gap	Normal Gap
Mounting Box Depth (Min)	25mm
Terminal Capacity	4 x 1.0mm ² , 4 x 1.5mm ² , 2 x 2.5mm ² , 1 x 4.0mm ²
Earth Terminal Capacity	4 x 1.0mm ² , 4 x 1.5mm ² , 2 x 2.5mm ² , 1 x 4.0mm ²
Fixing Centres	60.3mm
Size	86mm x 86mm x 4.5mm (Plate thickness)
Product Class 1	Face plate must be earthed
Ambient Operating Temperature	-5° to +40°C
Recommended Location	Internal Use Only
Maximum Installation Altitude	2000m
IP Rating	IP2XD
Switched Poles	Single
Mains Frequency	50hz - 60hz
Contact Gap Minimum	3mm